

# SPIRALAIR

## Oil-free Compressors

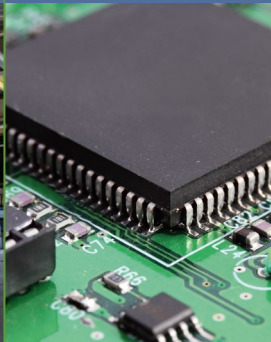
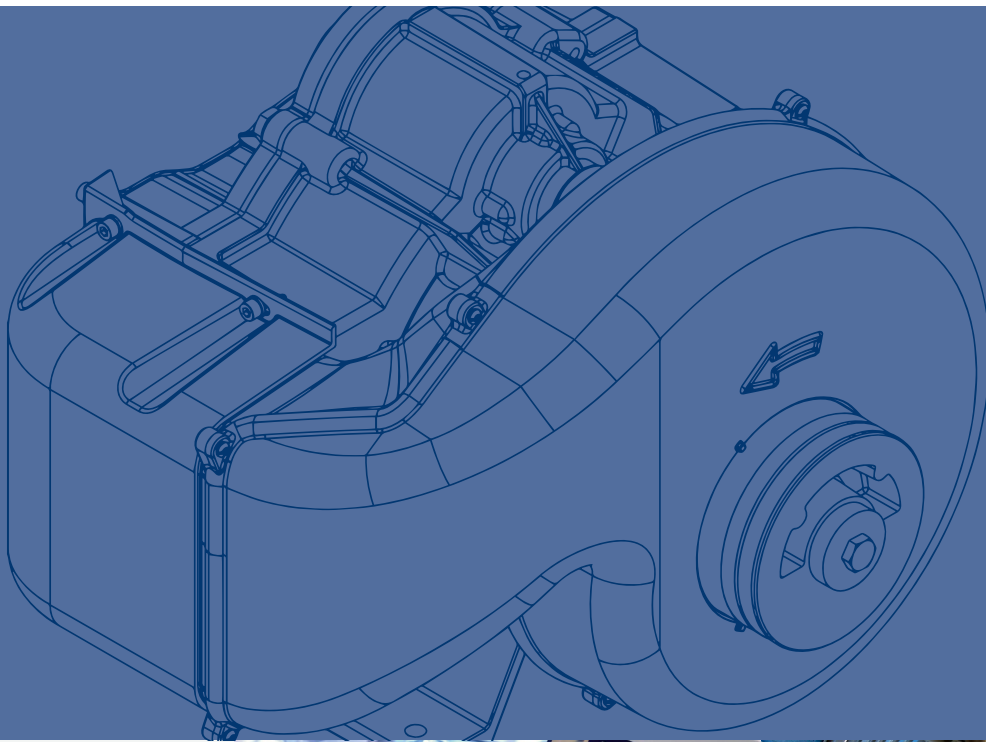

SPR 2-8

**Oil free**  
compressors

## Oil-free compressors

Some applications demand compressed air of the highest quality. Only oil-free air will give you that purity and peace of mind. By excluding any and all oil from the compression process, the SPR 2-8 gives you compressed air that meets the most stringent (Class 0) quality standard. But that is not all. With its smart design and advanced features, the SPR 2-8 delivers superior reliability and efficiency, making it a valuable addition to your compressor room.



### 100% clean, oil-free air

Only compressed air without any traces of oil can safeguard the integrity of your end products. By completely eliminating oil from the compression process, you remove the risk of application breakdowns or product contamination.

### Compact & quiet

Only compressed air without any traces of oil can safeguard the integrity of your end products. By completely eliminating oil from the compression process, you remove the risk of application breakdowns or product contamination.

### Energy efficient

The SPR's scroll element performs a continuous compression. This makes it inherently more efficient than piston compression technology, which typically experiences energy loss as a result of the "dead space" in its cylinder head. The SPR's small elements start and stop rapidly, saving energy by not having to run in unload.

### Robust & easy to maintain

European-made, high-quality components work together seamlessly to give you absolute reliability and superior performance. The SPR's vertical build allows easy accessibility of service parts for quick maintenance. Of course, the absence of oil completely cancels the need for regular oil changes.

### Minimal environmental impact

Thanks to its energy savings, the SPR will help reduce your environmental footprint. Of course, the SPR also exempts you from the need to safely change and dispose of compressor oil.



### SPR 2-8 by the numbers

- Class 0 air purity (ISO 8573)
- ≤54 dB
- IE3 motor
- 3.5" controller display
- 4 sizes, from 6.8-35.3 m<sup>3</sup>/hr

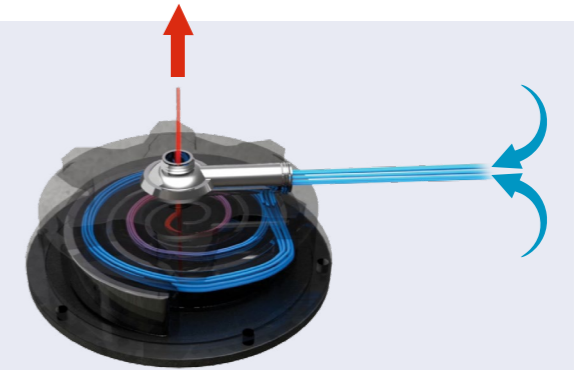

### No oil, no risk

Does your production require absolutely clean air because the immediate and long-term cost of product contamination would be immense? ISO 8573-1 Class 0 air quality was established for these types of critical applications. It's a standard only the oil-free compression technology of the SPR 2-8 can meet. So why run the risk when you can have guaranteed clean air?



Purity class	Concentration total oil (aerosol, liquid, vapour) mg/m <sup>3</sup>
0	As specified by the equipment user or supplier and more stringent than class 1
1	≤ 0,01
2	≤ 0,1
3	≤ 1
4	≤ 5

### Class 0 applications

Food & beverage | Electronics clean rooms | Pharmaceutical production | Hospital breathing air



### Free up floor space

We know you don't need more clutter on your production floor. That is why the SPR 2-8 is ultra-compact. That is also why its optional refrigerant dryer comes completely integrated in the unit's canopy. Even the SPR's air receivers don't require additional floor space, as they fit nicely underneath the compressor.

### Achieve your environmental goals

Sustainability is not a vague goal anymore. It has become a production KPI. The SPR's high-efficiency IE3 motor helps reduce your energy consumption and your environmental impact. In addition, its oil-free technology removes hazardous waste materials from your air generation process.

## State-of-the-art oil-free technology

- In-house designed air end manufactured in Belgium.
- Oversized cooler and smart airflow improve the lifetime of all parts.
- Premium materials avoid corrosion and ensure the Class 0 air quality.
- Insulated canopy and low-vibration design minimize sound levels.
- Optional integrated dryer delivers dry, quality air without taking up additional floor space.
- IE3/IP55 motor.
- Easily accessible greased bearings.
- Siemens-equipped cubicle.
- Stainless steel pipe connections.
- 24° leak-free pipe connections.



### Customize your SPR: options

- **Prefilter:** Prevents premature clogging of the inlet air filter in dusty environments.
- **Water separator:** Collects condensate to avoid corrosion.
- **Electronic drain:** Removes condensate from the compressed air system.
- **Refrigerant dryer:** Lowers the dew point down to 3°C for more critical applications.
- **Receivers:** Available in 2 sizes (270 and 500L), mountable below the compressor.
  - Epoxy coated
  - Available as ASME, AS1210, MOM,...
- **Graphic controller:** Significantly expands your control and monitoring options.
- **Phase sequence relay:** Protects unit rotation direction.



## Advanced control for ease of use

Do you prefer to keep a close eye on your compressor? The SPR's optional Graphic controller will give you all the monitoring and control features you need:

- Easy-to-use 3.5" display
- 4 clear status indications
- Warning icons
- Phase monitoring alarm when a power source is connected inappropriately
- Week timers and multiple pressure band selection for refined system control
- A simple connection to your central control room allows for remote desktop management



## Practical connectivity

Connect to the Graphic controller from your desktop and follow your SPR's performance up close from a distance. Performance stats and warnings are delivered right to your computer. You don't even need to walk to the machine to see when the next service intervention is due.



## Multiple compressor control

Are you running multiple compressors? The Graphic's Econroller functionality allows you to manage all units with one controller. In addition to the ease of use of this streamlined control, you can also optimize your compressors' reliability and efficiency. The Econroller evenly distributes loading hours so that service can be performed at the same time for all connected machines. It also reduces the pressure band width and the actual required pressure to increase your energy and cost savings.

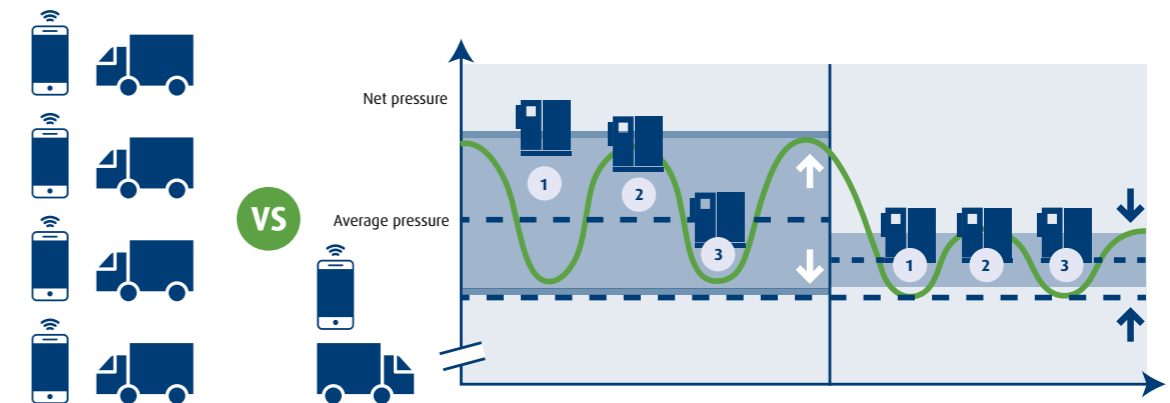

## 1 partner for all your quality air needs

### Filters

Your SPR 2-8 frees you from the requirement to install oil-related filters. If you need or prefer to remove downstream dust particles, one of our standard line filters will get the job done.



### Dryers

If your production demands a dew point below 3°C, our adsorption dryers give you a PDP as low as -70°C. Thanks to SPR's oil-free air, you enjoy optimal performance and lifetime of the dryer, as there is no oil that will stick to and compromise the desiccant.



### Gas generators

Does your production use industrial gases such as nitrogen? Why not produce your own N2 with your SPR and one of our gas generators? Ask our representative about our on-site gas generation solutions.

## 1 partner for all your service needs



### AIRnet distribution

Don't let your compressed air go to waste in a subpart distribution system. AIRnet is the easy to install, reliable solution.

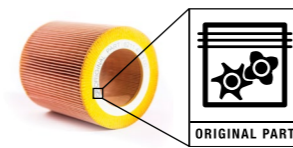

### Original parts

When it is time to service your compressor, a wide range of original parts is available to safeguard the quality and performance of your SPR.

## Technical specifications

Model	Max. working pressure	Free Air Delivery			Motor power		Noise level	Weight*
	bar	m <sup>3</sup> /h	l/s	cfm	kW	hp	dB(A)	std (kg)
SPR 2	8	10.4	2.9	6.1	1.5	2	53	110
	10	6.8	1.9	4.0				
SPR 3	8	15.1	4.2	8.9	2.2	3	55	124
	10	12.2	3.4	7.2				
SPR 5	8	24.1	6.7	14.2	3.7	5	57	144
	10	21.2	5.9	12.5				
SPR 8	8	35.3	9.8	20.8	5.5	7.5	59	144
	10	27.4	7.6	16.1				

\* The weight stated relates to the floor-mounted units without an integrated dryer. Machines are available in 50 and 60Hz.

### Dimensions (L x W x H)

	Length std mm	Width mm	Height mm
Frame-mounted	750	640	835
Frame-mounted + dryer	990	640	835
Tank-mounted 270L	1520	640	1335
Tank-mounted 500L	1844	640	1500

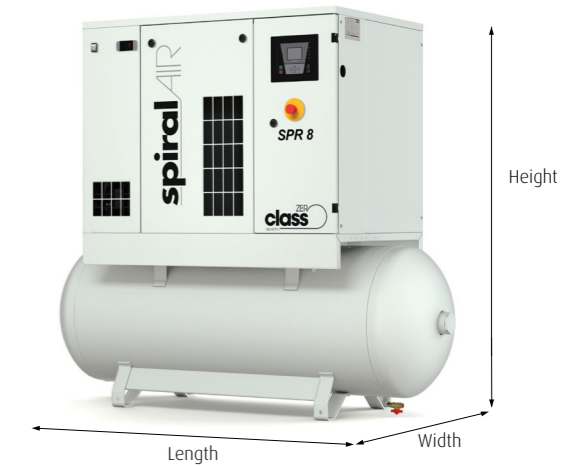
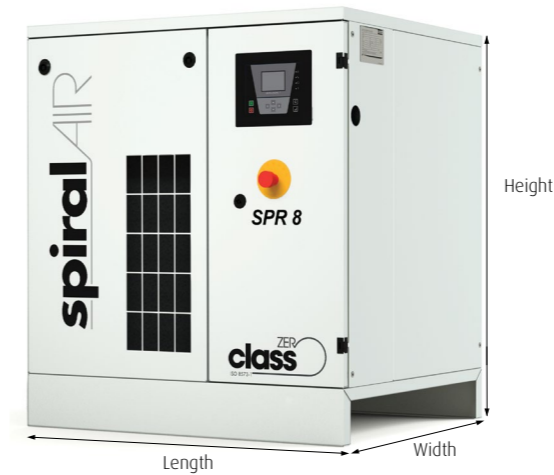



**DRIVEN BY TECHNOLOGY DESIGNED BY EXPERIENCE**



**CONTACT YOUR LOCAL  
SALES REPRESENTATIVE**

**Your authorised distributor**

6999010620